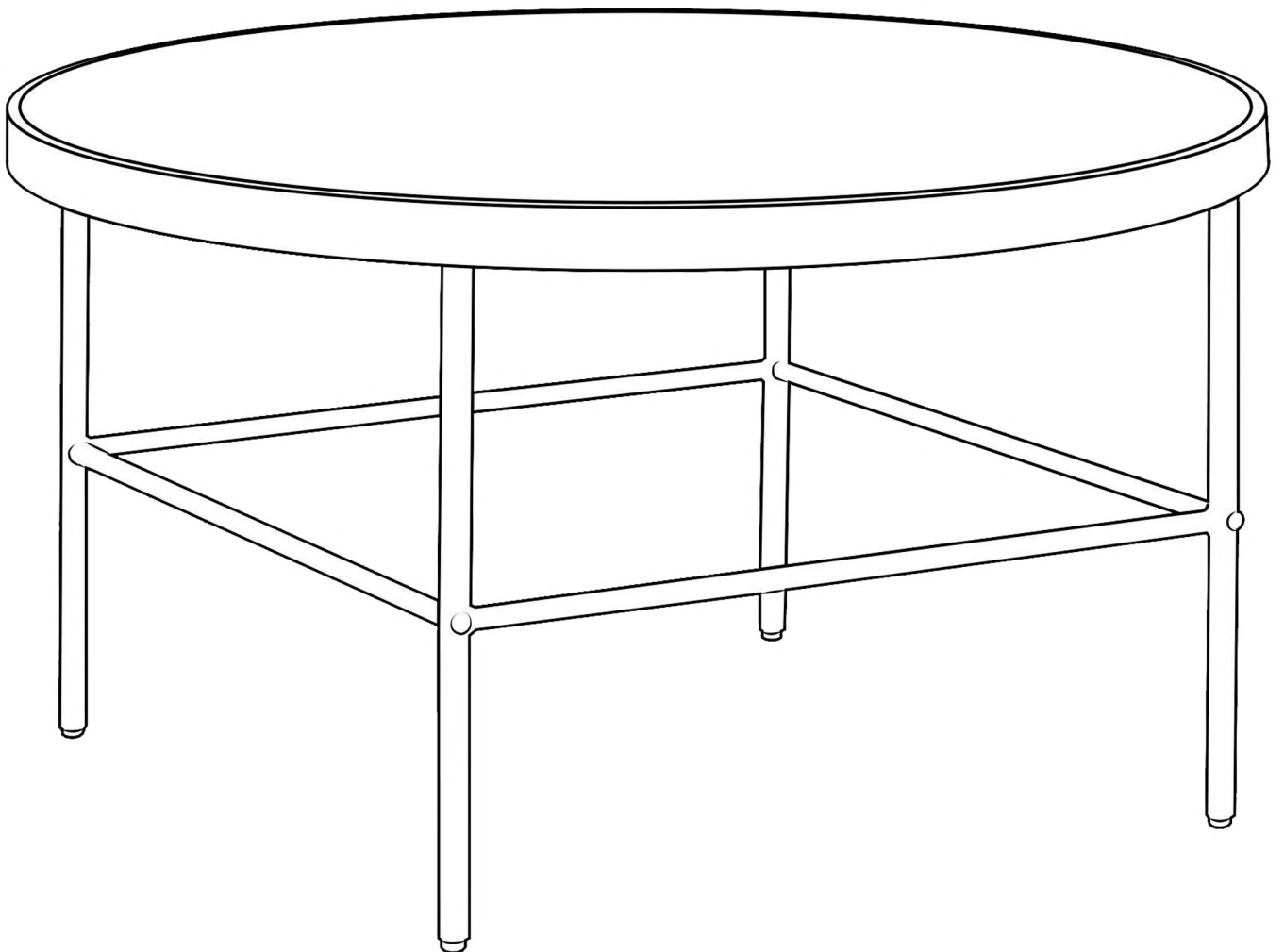
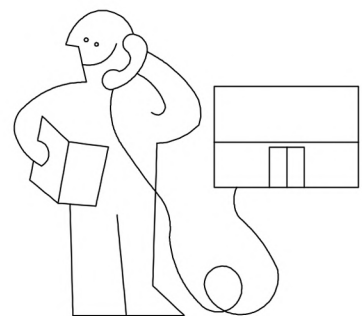
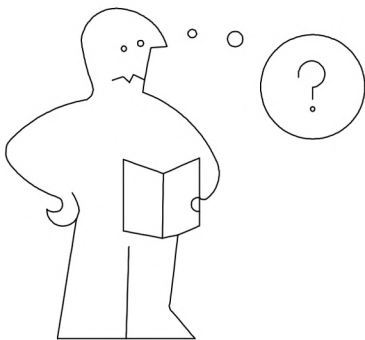
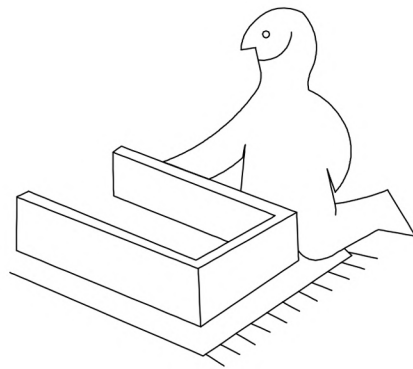
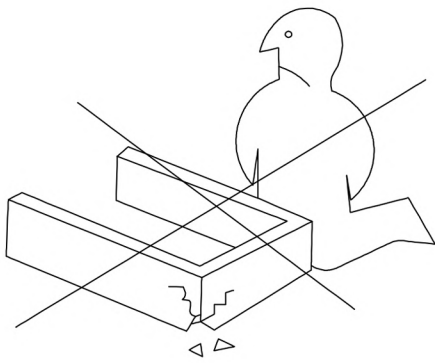
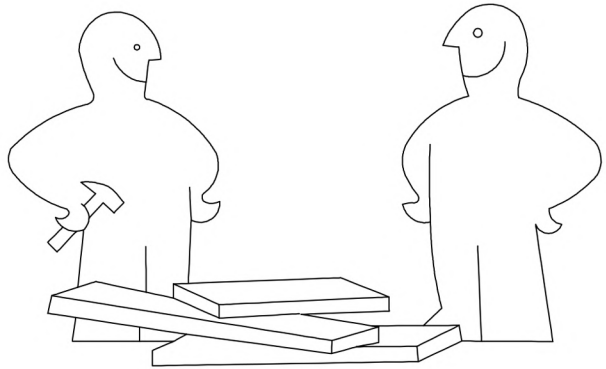
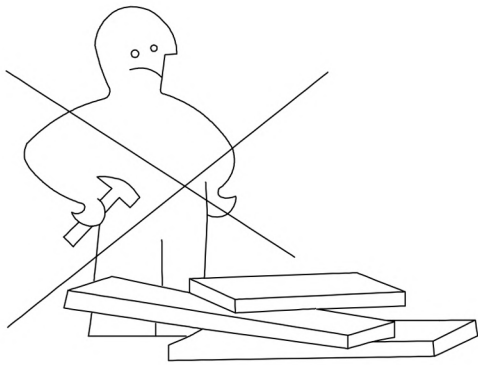
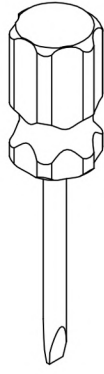
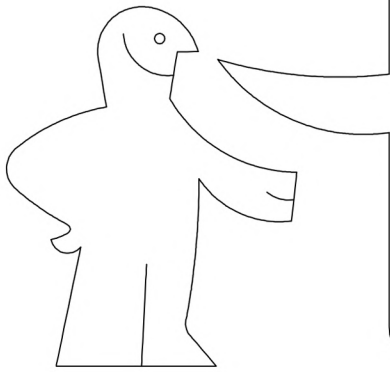


# SIXTINE


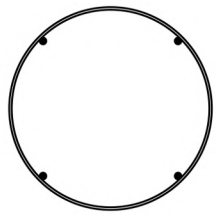
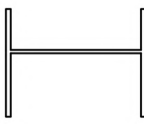

TABLE BASSE RONDE EN VERRE ET MÉTAL NOIR

## NOTICE DE MONTAGE

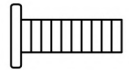







**LISTE DES PIÈCES**

<p>1-1 Pc.</p> 	<p>2-1 Pc.</p> 	<p>3-2 Pcs.</p> 	<p>4-2 Pcs.</p> 
--	--	--	---

**VISSERIE**

<p>A-4Pcs</p> 	<p>B-4Pcs</p> 	<p>C-1Pc</p> 	<p>D-4Pcs</p> 
---	---	---	---

