

BETA

FAUTEUIL DE BUREAU
NOTICE DE MONTAGE

DECO
INPARIS

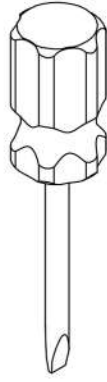

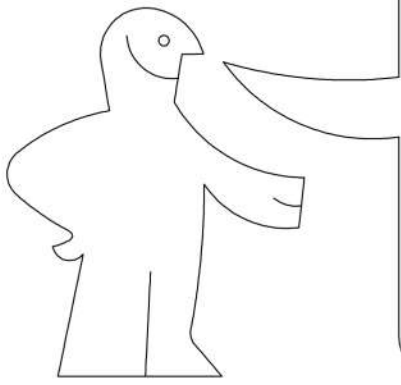

**DECO
IN PARIS**

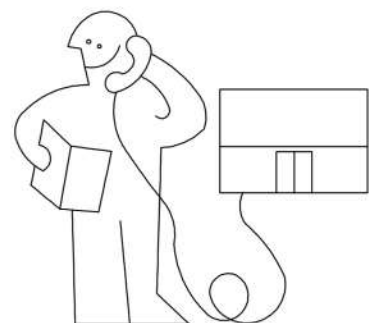
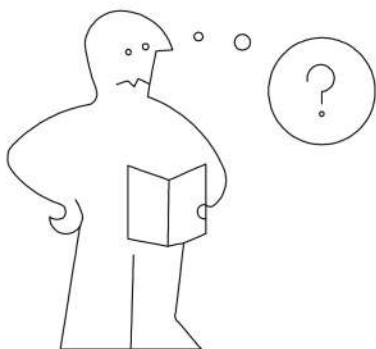
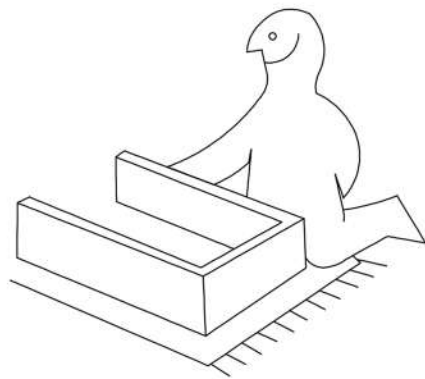
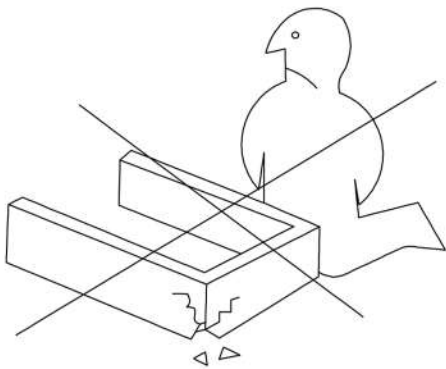
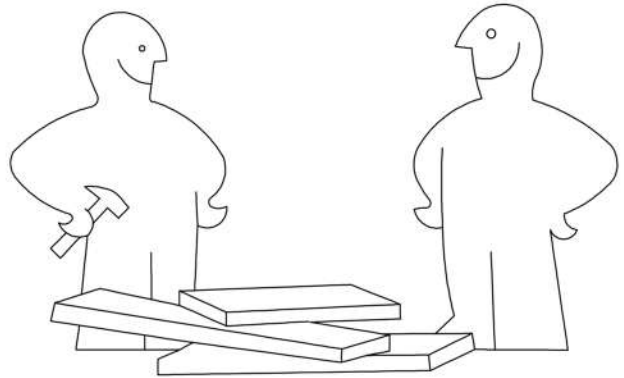
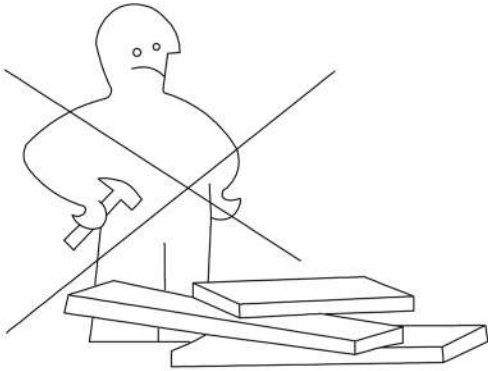

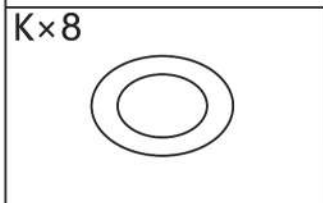
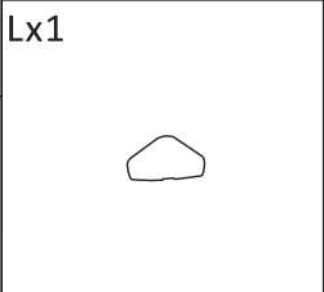
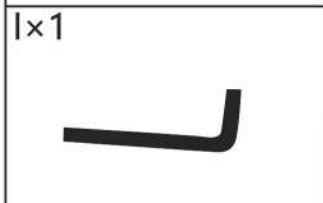
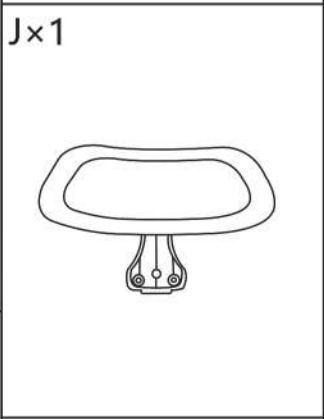
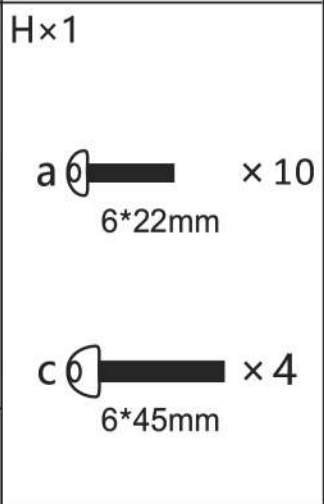
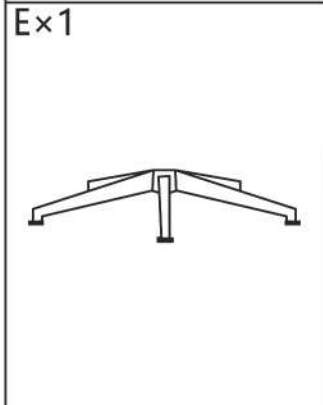
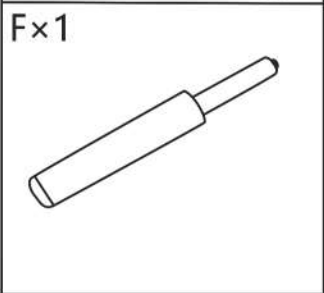
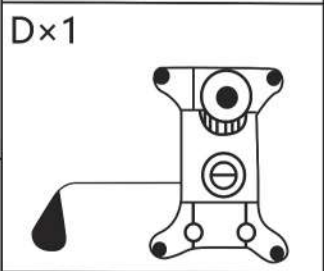
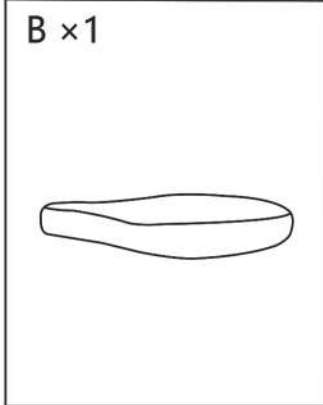
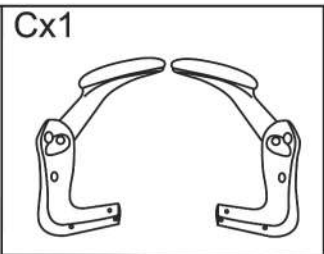
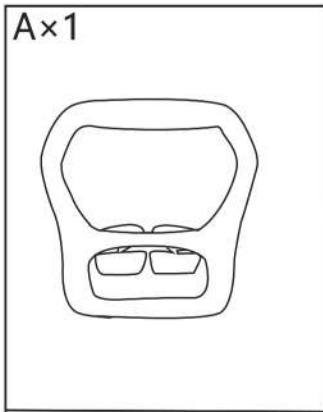

ETAPE 1

Placez les roues sur la base

ETAPE 2

Put the gas cylinder in the gas on the base

ETAPE 3

Note: Lors du montage, veuillez d'abord serrer à moitié toutes les vis dans les trous. Une fois toutes les vis fixées, serrez-les complètement.

Fixez la commande de siège sur bas du siège.
Veuillez noter la direction ! Assemblez le coussin de siège et les accoudoirs.

ETAPE 4

Note: Lors du montage, veuillez d'abord serrer à moitié toutes les vis dans les trous. Une fois toutes les vis fixées, serrez-les complètement.

NOTE: Veuillez assembler les accoudoirs et le dossier

ETAPE 5

ETAPE 6

Assembler la chaise en deux parties